

TOTAL

# OMTC

TOOLS & HARDWARE



**20V** 2.0/4.0Ah **MAX** **SHARE**

**P20S** SAME BATTERY **150+** TOOLS

Landline: (905) 450-0581  
Mobile: 437 245 9263  
Email: [Info@omctool.com](mailto:Info@omctool.com)  
Address: 212B Wilkinson Road,  
Brampton, Ontario  
[www.totaltoolscanada.com](http://www.totaltoolscanada.com)

# TOTAL

One-Stop Tools Station

**2022-2023**

### Lithium-Ion Brushless Hammer drill (Tool Only)

**TIDL120608A1**

20V



Battery and charger sold separately

Brushless Motor  
Voltage:20V  
No-load speed:0-450/0-1900rpm  
Max impact rate:22500/min  
Max torque:60NM  
Chuck capacity:1/2"  
Torque settings:23+1+1  
Auto-lock keyless chuck  
Mechanical 2-speed gear  
Spindle lock function  
Integrated work light  
LED battery power indicator  
With 47pcs accessories  
Battery and charger sold separately  
Packed by Color box

Unit	PACK /QTY	Qty/Ctn
PCS	1	5

### 20VX2.0AH Lithium-Ion Hammer drill Combo 1Battery+1Charger

**TIDL120608A**

20V



Brushless Motor  
Voltage:20V  
No-load speed:0-450/0-1900rpm  
Max impact rate:22500/min  
Max torque:60NM  
Chuck capacity:1/2"  
Torque settings:23+1+1  
Auto-lock keyless chuck  
Mechanical 2-speed gear  
Spindle lock function  
Charge volts:110-120V-50/60Hz  
Integrated work light  
LED battery power indicator  
With 1pcs 2.0Ah battery pack (TFBL12001A)

Unit	PACK /QTY	Qty/Ctn
PCS	1	5

### Lithium-Ion impact wrench (Tool Only)

**TIWLI2001A1**

20V



Battery and charger sold separately

Brushless motor  
Voltage:20V  
Square drive:1/2"  
No-load speed:0-1300/0-2100rpm  
Impact rate:0-2000/0-3300bpm  
Max torque:300NM  
Integrated work light  
LED battery power indicator  
With 3pcs sockets(17 19 21mm)  
Battery and charger sold separately  
Packed by color box

Unit	PACK /QTY	Qty/Ctn
PCS	1	10

### 20VX2.0AH Lithium-Ion impact wrench Combo 1Battery+ 1Charger

**TIWLI2001A**

20V



Brushless motor  
Voltage:20V  
Square drive:1/2"  
No-load speed:0-1300/0-2100rpm  
Impact rate:0-2000/0-3300bpm  
Max torque:300NM  
With 1pcs 2.0Ah battery pack(TFBL12001A)  
With 1pcs charger(TFCL12001A)  
Charge volts:110-120V-50/60Hz  
Integrated work light  
LED battery power indicator  
With 3pcs sockets(17 19 21mm)  
Packed by canvas bag

Unit	PACK /QTY	Qty/Ctn
PCS	1	5

### Lithium-Ion impact driver (Tool Only)

**TIRLI2002A1**

20V



Battery and charger sold separately

Brushless motor  
Voltage:20V  
Hex shank:1/4"  
No-load speed:0-1300/0-2100rpm  
Impact rate:0-2000/0-3300bpm  
Max torque:170NM  
Integrated work light  
LED battery power indicator  
With 2pcs screwdriver bits  
With 3pcs nut setters  
Battery and charger sold separately  
Packed by color box

Unit	PACK /QTY	Qty/Ctn
PCS	1	10

### 20VX2AH Lithium-Ion impact driver Combo 1 Battery+1 Charger

**TIRLI2002A**

20V



Brushless motor  
Voltage:20V  
Hex shank:1/4"  
No-load speed:0-1300/0-2100rpm  
Impact rate:0-2000/0-3300bpm  
Max torque:170NM  
With 1pcs 2.0Ah battery pack(TFBL12001A)  
With 1pcs charger(TFCL12001A)  
Charge volts:110-120V-50/60Hz  
Integrated work light  
LED battery power indicator  
With 2pcs screwdriver bits  
With 3pcs nut setters  
Packed by canvas bag

Unit	PACK /QTY	Qty/Ctn
PCS	1	5

### Lithium-Ion Brushless drill 2-Pc. Combo Kit

**TCKLI2006A**

20V



Voltage:20V  
With 1pcs lithium-ion cordless drill (TIDL120608A)  
With 1pcs lithium-ion impact driver (TIRLI2002A)  
Lithium-ion impact driver(TIRLI2002A):  
Brushless motor  
Hex shank:6.35mm  
No-load speed:0-1300/0-2100rpm  
Impact rate:0-2000/0-3300/min  
Max torque:170NM  
Lithium-ion cordless drill(TIDL120608A):  
Brushless motor  
Voltage:20V  
No-load speed:0-450/0-1900rpm

Unit	PACK /QTY	Qty/Ctn
SET	1	4

### Lithium-Ion multi-tool Combo 1 Battery+1 Charger

**TMLI2001A**

20V



Voltage:20V  
No-load speed:5000-20000rpm  
With 1pcs flexible scraper  
With 1pcs cutting saw blade  
With 1pcs segment saw blade  
With 1pcs hex key  
With 1pcs sanding base  
With 3pcs sanding paper  
Packed by color box

Unit	PACK /QTY	Qty/Ctn
PCS	1	8

### 5" Lithium-Ion random orbit sander Combo 1 Battery+1 Charger

**TROSLI2001A**

20V



5PCS

Voltage:20V  
No-load speed:10000/min  
Bottom bass:125mm  
With 5pcs sand papers  
Packed by color box

Unit	PACK /QTY	Qty/Ctn
PCS	1	4

### Lithium-Ion glue gun (Tool Only)

**TGGLI2001A**

20V



Battery and charger sold separately

Ø11mm x 3PCS

Voltage:20V  
Gluing capacity:15-18g/min  
Glue stick diameter:11.2mm  
Heat-up time:50sec  
With 3 pcs 150mm glue sticks  
Battery and charger sold separately  
Packed by double blister

Unit	PACK /QTY	Qty/Ctn
PCS	9	36

Lithium-Ion spray gun Combo 1 Battery+1 Charger

**TSGLI2001A**

20V

**P20S**



Voltage:20V  
Spraying Pressure:0.1-0.2Bar  
Max.flow:600ml/min  
Max.viscosity:40DIN-s  
Container capacity:800ml  
With 1 pcs viscosity measuring cup  
With 1 pcs nozzle cleaning needle  
Packed by color box

Unit	PACK /QTY	Qty/Ctn
PCS	1	8

Lithium-Ion grass trimmer (Tool Only)

**TGTLI20018A**

20V

**P20S**



Voltage:20V  
No-load speed:8200rpm  
Cutting diameter:300mm  
Line dia:1.6mm twisted  
Line length:5m  
Battery and charger sold separately  
Packed by color box

Unit	PACK /QTY	Qty/Ctn
PCS	1	2

20Vx2.0Ah Lithium-Ion grass trimmer Combo 1 Battery+1 Charger

**TGTLI20018A-**

20V

**P20S**

2.0Ah



Voltage:20V  
No-load speed:8200rpm  
Cutting diameter:300mm  
Line dia:1.6mm twisted  
Line length:5m  
Packed by color box

Unit	PACK /QTY	Qty/Ctn
PCS	1	2

18" Lithium-Ion hedge trimmer (Tool Only)

**THTLI20018A**

20V

**P20S**



Voltage:20V  
Maximum speed :2800spm  
Blade cutting length:18"  
Maximum cutting diameter:7/10"  
Laser cut blade  
Battery and charger sold separately  
Packed by color box

Unit	PACK /QTY	Qty/Ctn
PCS	1	2

20V 18" Lithium-Ion hedge trimmer Combo 1 Battery+1 Charger

**THTLI20018A-**

20V

**P20S**

2.0Ah



Voltage:20V  
Maximum speed :2800spm  
Blade cutting length:18"  
Maximum cutting diameter:7/10"  
Laser cut blade  
Packed by color box

Unit	PACK /QTY	Qty/Ctn
PCS	1	2

Lithium-Ion blower (Tool Only)

**TABLI20028A**

20V

**P20S**

BLMOTOR



Brushless Motor  
Voltage:20V  
No-load speed :15000rpm  
Average air volume:8.5m3/min  
Maximum air speed:144km/h  
Battery and charger sold separately  
Packed by color box

Unit	PACK /QTY	Qty/Ctn
PCS	1	2

20Vx4.0Ah Lithium-Ion blower Combo 1 Battery+1 Charger

**TABLI20028A-**

20V

**P20S**

BLMOTOR

2.0Ah



Brushless Motor  
Voltage:20V  
No-load speed :15000rpm  
Average air volume:8.5m3/min  
Maximum air speed:144km/h  
Packed by color box

Unit	PACK /QTY	Qty/Ctn
PCS	1	2

2.0Ah Lithium-Ion battery pack

**TFBLI2001A**

2.0Ah

**P20S**

2.0Ah



Voltage:20V  
Lithium-Ion 2.0Ah battery  
LED battery power indicator  
One battery fits all 20V multiple tools  
Packed by color box

Unit	PACK /QTY	Qty/Ctn
PCS	1	20

2A Fast intelligent charger

**TFCLI2001A**

2A

**P20S**

2.0A



Input voltage: 110-120V-50/60Hz  
Output voltage:20V  
Output current:2A  
Packed by color box

Unit	PACK /QTY	Qty/Ctn
PCS	1	20

4A Fast intelligent charger

**TFCLI2003A**

4A

**P20S**

4.0A



Input voltage: 110-120V-50/60Hz  
Output voltage:21V  
Output current:4A  
Packed by color box

Unit	PACK /QTY	Qty/Ctn
PCS	1	20

**4" Magnetic Welding Holder**

**TAMWH50042**      **4"**



**4" 50LBS**

Magnetic Welding Holder  
Pull Force: 50 Lbs  
Specifications: 4"  
Product Dimensions: 155\*102\*17.4mm  
Weight: 591g  
Angles: 45°, 90°, 135°  
Material: Magnet and Steel  
Packed by double blister

Unit	PACK /QTY	Qty/Ctn
PCS	6	30

**800A Electrode holder**

**TWAH8006**      **800A**



**800A**  
Copper

New design  
Unique design

Unique design new design  
Rated current: 800A  
Suitable for MMA welder(Below 630A)  
Packed by carton box

Unit	PACK /QTY	Qty/Ctn
PCS	1	30

**Brad nailer(+1000 PCS Brad Nails)**

**TAT83501**      **Ga18**



**Ga18**

Load capacity: 100pcs  
Brad size: 15-50mm  
Ga18, 1.25x1.00mm  
Quick-release nosepiece for fast clearing of jams.  
With Europe type connector, USA type connector, Nitro type connector and Italy type connector.  
Operation pressure: 0.4-0.7Mpa(60-100Psi)  
With 1000pcs brad nails  
Packed by color box

Unit	PACK /QTY	Qty/Ctn
PCS	1	5

**G18X2" Brad nail (5000 PCS)**

**TAC918501**      **50mm**



**50x1.25x1.0mm 18Ga**  
5000PCS

Brad Length: 50mm  
5000pcs/color box  
Suitable for TAT81501, TAT83501, TCBNLI2028, TCBNLI2001, TCBNLI2001-4, TCBNLI2016, UTCBNLI2016 Ga18, 1.25X1.0mm  
Packed by color box

Unit	PACK /QTY	Qty/Ctn
SET	1	10

**1/8" HSS drill bit**

**TAC1001083**      **1/8"**



**10PCS/SET**  
Ø1/8"

HSS, diameter: 1/8"  
10pcs/poly bag  
Packed by poly bag

Unit	PACK /QTY	Qty/Ctn
PCS	100	4200

**3/16" HSS drill bit**

**TAC1003163**      **3/16"**



**10PCS/SET**

HSS, diameter: 3/16"  
10pcs/poly bag  
Packed by poly bag

Unit	PACK /QTY	Qty/Ctn
PCS	100	2100

**1/4" HSS drill bit**

**TAC1001043**      **1/4"**



**10PCS/SET**  
Ø1/4"

HSS, diameter: 1/4"  
10pcs/poly bag  
Packed by poly bag

Unit	PACK /QTY	Qty/Ctn
PCS	50	1100

**5/32"x3" Masonry drill bit**

**TAC2105321**      **5/32"x3"**



5/32"x3"  
Packed by plastic bag

Unit	PACK /QTY	Qty/Ctn
PCS	250	500

**1/4"X6-1/4" SDS PLUS Hammer Drill Bit**

**TAC3101042**      **3/8"x10 1/4"**



1/4"X 6-1/4", SDS plus  
Packed by plastic hanger

Unit	PACK /QTY	Qty/Ctn
PCS	60	180

**3/8"X10-1/4" SDS PLUS Hammer Drill Bit**

**TAC3103084**      **1/2"x10-1/4"**



3/8"x10 1/4", SDS plus  
Packed by plastic hanger

Unit	PACK /QTY	Qty/Ctn
PCS	50	150

1/2"X10-1/4" SDS PLUS Hammer Drill Bit

TAC3101023 1/2"x10-1/4"



1/2" X 10-1/4".SDS plus  
Packed by plastic hanger

Unit	PACK /QTY	Qty/Ctn
PCS	40	120

3/4"(20mm) flat SDS plus chisel

TAC15121411 14x250x20mm

14x250x20mm



14X250 X 20mm,flat  
Packed by plastic hanger

Unit	PACK /QTY	Qty/Ctn
PCS	1	50

1.5" (40mm) flat SDS plus chisel

TAC15121412 14x250x40mm

14x250x40mm



14X250 X 40mm,flat  
Packed by plastic hanger

Unit	PACK /QTY	Qty/Ctn
PCS	1	50

11" Pointed Hex chisel

TAC153171 17x280mm

17x280mm



17x280mm, pointed  
For item  
TH213006,TH2130016,UTH2130016  
Packed by plastic tube

Unit	PACK /QTY	Qty/Ctn
PCS	1	50

11"x7/8" flat Hex chisel

TAC153172 17x280x22mm

17x280x22mm



17x280x22mm, flat  
For item  
TH213006,TH2130016,UTH2130016  
Packed by plastic tube

Unit	PACK /QTY	Qty/Ctn
PCS	1	50

4.5"X3/64"X7/8"10PCS metal cutting disc set

TAC2211155 115x1.2x22.2

10PCS/BOX  
115x1.2mm



10Pcs/set  
10Pcs/shrink  
115mm(4-1/2")X1.2mm (3/64")X22.2mm (7/8")  
Flat centre  
Cutting disc for metal  
Packed by metal box

Unit	PACK /QTY	Qty/Ctn
SET	10	40

4.5"X3/64"X7/8" Abrasive metal cutting disc

TAC2211151 115x1.2x22.2

115x1.2mm



Flat

115mm(4/ 1/2")X1.2mm(3/64")X22.2mm (7/8")  
Flat centre  
cutting disc for metal  
Packed by label

Unit	PACK /QTY	Qty/Ctn
PCS	100	400

5"X3/64"X7/8" Abrasive metal cutting disc

TAC2211253 125x1.2x22.2

125x1.2mm



Flat

125MM(5")X1.2MM(3/64")X22.2MM(7/8")  
Flat centre  
cutting disc for metal  
Packed by label

Unit	PACK /QTY	Qty/Ctn
PCS	100	400

5"X7/8" Turbo diamond disc

TAC2131251 125x22mm

125mm



Clean Cut



125(5")X22.2mm  
Blade width:10mm  
Packed by color box

Unit	PACK /QTY	Qty/Ctn
PCS	25	100

7"X7/8"X3/8" Dry diamond disc

TAC2111801 180x22mm

180mm



Fast Cut



180(7")X22.2mm  
Blade width:10mm  
Packed by color box

Unit	PACK /QTY	Qty/Ctn
PCS	10	40

4.5"X7/8" Ultrathin diamond disc (Mesh Rim)

**TAC2181151HT** 115x22.2mm



115(4-1/2")\*22.2MM  
Blade height:10mm  
Blade Thickness:1.4mm  
Matrix Thickness:0.8mm  
Material: 75Cr1  
With flange plate  
Packed by double blister

Unit	PACK /QTY	Qty/Ctn
PCS	50	100

4 1/2"X7/8" Ultrathin diamond disc

**TAC2131151HT** 115x22.2mm

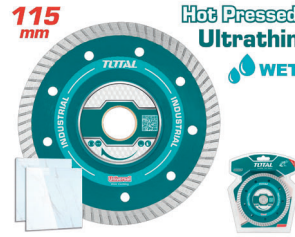

115mm X 22.2mm  
Blade width:8mm  
Metal base thickness:0.8mm  
With flange plate  
Universal purpose:ceramic,tile,marble,brick  
Forbidden to use for Vitrified brick (nano glass)  
Packed by double blister

Unit	PACK /QTY	Qty/Ctn
PCS	50	100

4.5" double row cup grinding wheel

**TAC2421151** 115x22.22mm



Diameter:115mm  
18pcs blades  
Arbor:22.22mm  
Packed by color box

Unit	PACK /QTY	Qty/Ctn
PCS	1	20

TCT saw blade 4-1/2" 40T for wood

**TAC231255** 115x22.2mm



115mm(4-1/2")  
40T,arbor:22.2mm  
Reduction ring:16mm  
Wood Cutting  
Packed by color box

Unit	PACK /QTY	Qty/Ctn
PCS	25	100

TCT saw blade 7-1/4"(185MM)X5/8" 24T for wood

**TAC231401** 185x16mm



185mm(7-1/4")  
24T,arbor:16mm  
Suitable for circular saw  
Wood cutting  
Packed by color box

Unit	PACK /QTY	Qty/Ctn
PCS	25	50

TCT saw blade 10" 100T for Aluminum

**TAC2337210** 254x30mm

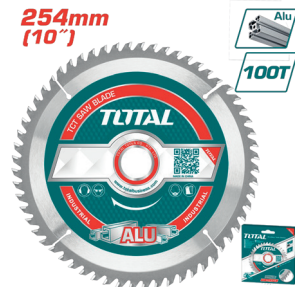

254mm(10")  
100T,arbor:30mm  
16mm and 25.4mm ring  
Suitable for mitre saw  
For Item TS42182551 TS42182552  
Aluminum cutting  
Packed by color box

Unit	PACK /QTY	Qty/Ctn
PCS	5	25

Wire end brushes with shank

**TAC37011** 25mm/1"



Dia: 25mm, 1"  
Shank dia: 1/4"  
Wire dia: 0.3mm  
Wire length: 25mm  
RPM: 4500r/min  
Apply on: planing, deburring, edge honing,  
descaling/paint stripping, weld seams  
Suitable for: Steel, Cast steel, Soft wood, Hard wood

Unit	PACK /QTY	Qty/Ctn
PCS	20	240

3" Wire cup brush

**UTAC32031** 75mm/ 3"



Dia: 75mm, 3"  
Thread: 5/8"-11UNC  
Wire dia: 0.5mm  
Wire length: 23mm  
RPM: 12500r/min  
Apply on: roughening, descaling/paint stripping,  
Apply on: roughening, descaling/paint stripping, weld seams  
Suitable for: Steel, Cast steel  
Packed by double blister

Unit	PACK /QTY	Qty/Ctn
PCS	10	80

2" Nylon Cup brush with shank

**TAC33025** 50mm/2"



Dia: 50mm, 2"  
Shank dia: 1/4"  
Wire dia: 1.2mm  
Wire length: 17mm  
RPM: 4500r/min  
Apply on: roughening, structuring, descaling/  
paint stripping  
Suitable for: Steel, Cast steel, Stainless steel,  
Non-ferrous metal, Aluminium, Soft wood,  
Hard wood  
Packed by double blister

Unit	PACK /QTY	Qty/Ctn
PCS	10	120

PH2X 1/2" 10PCS Screwdriver bit set

**TAC16PH233** S2



PH2, 65mm, 10pcs/set  
Double end bits  
S2 Industrial steel  
Nickle plated magnetic  
Packed by plastic box

Unit	PACK /QTY	Qty/Ctn
SET	25	100

### 5PCS Jig saw blade for wood set

TAC51101D

75mm

5PCS/SET



Clean for wood  
Length of tooth:75mm, tooth space:4-5.2mm  
Softwood, chipboards, wood core plywood,  
fibre boards (10-45 mm),5pcs/set  
HCS,Ground teeth and taper ground  
Packed by blister card

Unit	PACK /QTY	Qty/Ctn
SET	25	250

### Reciprocating saw blade for wood

TAC52644D

150mm

2PCS/SET

150x19x1.25mm



Suitable for Wood  
150mmx19mmx1.25mm  
6TPI - HCS - Milled  
Suitable for TS100806  
1/2" shank,2pcs/set  
Fast cutting for wood, composition materials  
and plastic(dia.<100mm)  
Packed by blister card

Unit	PACK /QTY	Qty/Ctn
SET	25	100

### Reciprocating saw blade for metal

TAC52922EF

150mm

2PCS/SET

150x19x0.9mm



Flexible for Metal  
150mmx19mmx0.9mm  
18TPI - Bi-Metal - Milled  
Suitable for TS100806  
1/2" shank,2pcs/set  
Cuts all metals including nonferrous pipe  
(<100mm) conduit, stainless and sheet metals  
(1.5-4mm)  
Packed by blister card

Unit	PACK /QTY	Qty/Ctn
SET	25	100

### 2-1/2" Hole core bit

TAC430651

65mm

65mm(2-9/16")

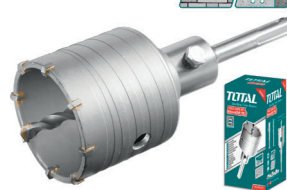

Diameter:65mm  
8pcs TCT blades  
With 1pcs 110mm adaptor  
With 1pcs 8X110mm masonry drill bit  
Packed by color box

Unit	PACK /QTY	Qty/Ctn
SET	1	24

### 6" Hole core bit

TAC4301501

150mm

150mm(6")



Diameter:150mm  
16pcs TCT blades  
With 1pcs 110mm adaptor  
With 1pcs 8X110mm masonry drill bit  
Packed by color box

Unit	PACK /QTY	Qty/Ctn
SET	1	8

### 14" SDS PLUS Adaptor(for Hole Core bit)

TAC43A13501

350mm

350mm

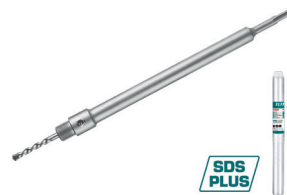

Shank:SDS Plus  
Thread:M22  
Length:350mm  
With 1pcs 8X110mm drill bit  
Suitable for item TAC430501 TAC430651  
TAC430801 TAC431001  
Packed by plastic tube

Unit	PACK /QTY	Qty/Ctn
PCS	1	30

### 1"X1-1/2" Bi-metal Hole saw

TAC410251

25mm

25mm(1")



Diameter:25mm  
Cutting depth:38mm  
Material:HSS M3 Bi-metal  
Variable teeth 4-6TPI  
Packed by double blister

Unit	PACK /QTY	Qty/Ctn
PCS	10	50

### 1-3/4"X1-1/2" Bi-metal Hole saw

TAC410461

46mm

46mm(1-13/16")



Diameter:46mm  
Cutting depth:38mm  
Material:HSS M3 Bi-metal  
Variable teeth 4-6TPI  
Packed by double blister

Unit	PACK /QTY	Qty/Ctn
PCS	10	50

### 4-1/2"X1-1/2" Bi-metal Hole saw

TAC4111412

114mm(4-1/2")



Diameter:114mm(4-1/2")  
Cutting depth:38mm(1-1/2")  
Material:HSS M3 Bi-metal  
Variable teeth 4/6  
Packed by double blister

Unit	PACK /QTY	Qty/Ctn
PCS	5	10

### 7/16" Arbor for hole saw

TAC4202

7/16"

11mm(7/16")



Arbor for hole saw  
Hex shank 7/16"  
Fit hole saws 32 to 210mm  
Packed by double blister

Unit	PACK /QTY	Qty/Ctn
PCS	10	60

**4.5" P40 Flap disc for Steel**

**TAC631151** P40

**115mm(4-1/2")** P40



Size: 115mm\*22mm,P40  
suitable for high steel, steel, cast iron and sheet steel  
Packed by label

Unit	PACK /QTY	Qty/Ctn
PCS	1	60

**4.5" P80 Zirconium flap disc for Stainless**

**TAC641153** P80

**115mm(4-1/2")** P80



Size: 115mm\*22mm (4-1/2"\*7/8") ,P80  
Especially suitable for stainless steel  
Material:Zirconium Oxide Abrasive  
MPA approved  
Packed by label

Unit	PACK /QTY	Qty/Ctn
PCS	1	200

**5" P80 Zirconium flap disc for Stainless**

**TAC641253** P80

**125mm(5")** P80



Size: 125mmx22mm (5"x7/8") ,P80  
Especially suitable for stainless steel  
Material:Zirconium Oxide Abrasive  
MPA approved  
Packed by label

Unit	PACK /QTY	Qty/Ctn
PCS	1	200

**24" SDS MAX Adaptor(For Hole Core bit)**

**TAC43C16002** SDS MAX

**600mm**



Shank:SDS MAX,  
Thread:M22\*2  
Length:600mm  
Width:1pcs 6X110mm drill bit  
Packed by plastic tube

Unit	PACK /QTY	Qty/Ctn
SET	1	10

**200z Claw hammer**

**THT73206** 560g/20oz

**20oz** Fibreglass handle



Weight: 20oz/560g  
Drop-forged hammerhead  
Heat treatment,45# carbon steel  
Unique design fibreglass handle  
Packed by label

Drop forged

Unit	PACK /QTY	Qty/Ctn
PCS	6	18

**320z Ball pein hammer(Fiberglass Handle)**

**THT74326** 900g/32oz

**32oz** Fibreglass handle



Weight: 32oz/900g  
Drop-forged hammerhead  
Heat treatment,45# carbon steel  
Unique design fibreglass handle  
Packed by label

Drop forged

Unit	PACK /QTY	Qty/Ctn
PCS	6	18

**350z Stoning hammer**

**THTSTH10006** 1000g

**1000g** Fibreglass handle



Weight:1000g  
Drop-forged hammerhead  
Heat treatment,45# carbon steel  
Unique design fibreglass handle  
Packed by label

Drop forged

Unit	PACK /QTY	Qty/Ctn
PCS	6	12

**320z White Rubber Mallet**

**THT763236** 32oz/900g

**32oz** Fibreglass handle



Weight:32oz/900g  
Natural rubber,soft type  
Unique design fibreglass handle  
Packed by label

Rubber

Unit	PACK /QTY	Qty/Ctn
PCS	6	24

**350z Axe**

**THT7810006** 1000g

**1000g** Fibreglass handle



Weight:1000g  
Drop-forged axe head  
Heat treatment,45# carbon steel  
Unique design fibreglass handle  
Packed by label

Drop forged

Unit	PACK /QTY	Qty/Ctn
PCS	6	12

**10LB Sledge hammer**

**THT750416** 10LB

**10LB** Fibreglass handle



Weight:10LB  
Drop-forged hammerhead  
Heat treatment,45# carbon steel  
Unique design fibreglass handle  
Packed by label

Drop forged

Unit	PACK /QTY	Qty/Ctn
PCS	1	4



**8" Industrial Combination pliers**

**THT210806** 200mm/8"



Size: 8"/200mm  
Cr-V, black finish and polish  
Two color handle  
Packed by PP hanger

Unit	PACK /QTY	Qty/Ctn
PCS	6	36

**7" Industrial Diagonal cutting pliers**

**THT230706** 180mm/7"



Size: 7"/180mm  
Cr-V, black finish and polish  
Two color handle  
Packed by PP hanger

Unit	PACK /QTY	Qty/Ctn
PCS	6	36

**9.5" High leverage combination pliers**

**THT210906S** 240mm/9.5"



Size: 9.5"/240mm  
Cr-V, black finish and polish  
TPR three color handle  
Saving 30% strength than normal pliers  
Packed by PP hanger

Unit	PACK /QTY	Qty/Ctn
PCS	6	36

**3pcs High leverage pliers**

**THT2K0301S** 3PCS



**3PCS/SET**  
Save 30% Strength  
200mm(8")  
180mm(7")  
160mm(6")

Size:  
8" High leverage combination pliers  
7" High leverage diagonal cutting pliers  
6" High leverage long nose pliers  
Cr-V, black finish and polish  
TPR three color handle  
Saving 30% strength than normal pliers  
Packed by PP hanger

Unit	PACK /QTY	Qty/Ctn
SET	5	20

**10" Industrial Quick Open Groove Joint Plier**

**THTJ381006** 250mm/10"



Size: 10"/250mm  
Quick-open type  
Max clamping open: 45mm  
CrNi, black finish and polish  
TPR two color handle  
Packed by PP hanger

Unit	PACK /QTY	Qty/Ctn
PCS	6	36

**7" End cutting pliers**

**THT260702** 180mm/7"



Size: 7"/180mm  
Cr-V, black finish and polish  
Packed by PP hanger

Unit	PACK /QTY	Qty/Ctn
PCS	6	36

**10" Industrial Straight jaw plier**

**THT191005** 10"



Cr-V  
Size: 10"  
HRC52-HRC60  
Nickel plated  
Packed by half double blister

Unit	PACK /QTY	Qty/Ctn
PCS	5	30

**Automatic wire stripper (Cutting, Stripping, Crimping)**

**THT15246** 3 in 1



3 in 1 multi-function  
Stripping, cutting and crimping  
Stripping wires range: 10AWG-24AWG  
(0.2-6mm<sup>2</sup>)  
Cutting function: copper and aluminum wires  
Crimping function:  
Crimp the insulated terminals 0.5-6mm<sup>2</sup> (10-22 AWG);  
Crimp the non-insulated terminals: 0.5-6mm<sup>2</sup> (4-22 AWG);  
Crimp the ignition terminals: 7-8mm<sup>2</sup>  
Durable and comfortable handle  
Packed by sliding card

Unit	PACK /QTY	Qty/Ctn
PCS	12	48

**Ratchet crimping plier (0.25-10mm<sup>2</sup>)**

**THCPG2510** 0.25-10mm<sup>2</sup>



Crimping range: 0.25-10mm<sup>2</sup>  
For tubular bare terminals and pre-insulated terminals  
AWG: 23-7  
Length: 6"  
Unique design handle  
Pressure force can be adjusted, fit for various terminals  
Packing by sliding card

Unit	PACK /QTY	Qty/Ctn
PCS	10	40

**24" Pipe wrench (Coated Handle)**

**THT171246** 600mm/24"



Size: 24"  
Max clamping diameter: 76mm  
Mobile jaw drop-forged with high quality carbon steel  
Inactivate treatment  
Body material: ductile cast iron  
Black finish and polish  
Solid rivet  
Packed by paper card

Unit	PACK /QTY	Qty/Ctn
PCS	1	4

10" Self adjusting pipe wrench

THT171102 250mm/10"



Size: 10"/250mm  
Clamping diameter: 14-40mm  
Carbon steel  
Black finish and polish  
Packed by paper card

Unit	PACK /QTY	Qty/Ctn
PCS	6	24

14" Aluminum Handle Pipe Wrench

THTAL17146 350mm/14"



Size: 14" (350mm)  
Max clamping diameter: 50mm  
Aluminum Handle, easy to use  
Mobile jaw drop-forged with high quality carbon steel  
Solid rivet  
Packed by paper card

Unit	PACK /QTY	Qty/Ctn
PCS	6	18

24" Bolt cutter (TPR Handle)

THT113246 24"



Size: 24"  
Cr-V blade  
Black finish and polish  
TPR two color handle  
Packed by paper card

Unit	PACK /QTY	Qty/Ctn
PCS	1	6

6" Cable cutter

THT11561 160mm/6"



Size: 6"/160mm  
Black finish and polish  
Carbon steel  
Packed by half double blister

Unit	PACK /QTY	Qty/Ctn
PCS	6	90

24" Cable cutter

THT115242 24"



Size: 24"  
Blades material: 65Mn  
Used for cutting copper and aluminum cable.  
Not for cutting ACSR, wire rope, steel or self supporting strand  
Cutting area: 240mm<sup>2</sup>  
Body heat treatment, cutting edges induction quenched  
Packed by paper card

Unit	PACK /QTY	Qty/Ctn
PCS	1	6

PVC pipe cutter

THT534216 3-42mm



Length: 193mm  
Cutting diameter: 3-42mm  
Material: Aluminum  
Packed by double blister

Unit	PACK /QTY	Qty/Ctn
PCS	6	48

Pipe cutter

THT53321 3-32mm

3-32mm Cutting Range



Copper and aluminum pipe cutter  
Cutting diameter: 3-32mm  
With high quality blade and aluminum knob  
Packed by sliding card

Unit	PACK /QTY	Qty/Ctn
PCS	12	48

S2X6" Square screwdriver

THT86S2150 6.0mm



1pcs screwdriver with 1pcs plastic hanger  
Cr-V, S2, Round shank  
Diameter: 6.0mm  
Length: 150mm  
Pack by plastic hanger

Unit	PACK /QTY	Qty/Ctn
PCS	12	144

5/16"X8" Slotted screwdriver

THT268200 S2



1pcs screwdriver with 1pcs plastic hanger  
S2, Round shank  
Slotted: 8.0mm  
Diameter: 8.0mm  
Length: 200mm  
Packed by plastic hanger

Unit	PACK /QTY	Qty/Ctn
PCS	12	144

PH2X6" Phillips screwdriver

THT26PH2150 S2



1pcs screwdriver with 1pcs plastic hanger  
S2, PH2, Round shank  
diameter: 6.0mm  
length: 150mm  
Packed by plastic hanger

Unit	PACK /QTY	Qty/Ctn
PCS	12	144

4 pcs screwdriver set

THT250604

Cr-V



4PCS/SET



4 pcs screwdriver set  
New design handle  
Material: CrV  
Round blade  
1pcs SL5.5X100mm  
1pcs SL6.5X150mm  
1pcs PH1X100mm  
1pcs PH2X150mm  
Packed by plastic hanger

Unit	PACK /QTY	Qty/Ctn
SET	10	30

32Pcs Industrial precision screwdriver set

TACSD30326

32Pcs



32PCS/SET



32PCS precision screwdriver set  
1Pcs Style handle  
1Pcs 4X60mm bits holder  
30PCS 4X28mm bits:  
SL1.5, SL2, SL2.5, SL3, SL3.5, SL4, PH000, PH0  
0, PH0, PH1, T4, T5, T6, T7, T8, T9, T10, T15, T20  
HO, 9, H1.3, H1.5, H2, H2.5, H3, H4, Y2, U2, 6, Fi  
ve Star0.8, Five Star1.2, Five Star0.8, Five  
Star1.2 is suitable for iPhone and iPad  
Packed by plastic box

Unit	PACK /QTY	Qty/Ctn
SET	10	120

9PCS Long Ball point hex key

THT106292

Cr-V

9PCS/SET



9pcs ball point hex key set  
Material: Cr-V  
Size: 1.5mm, 2mm, 2.5mm, 3mm, 4mm, 5mm, 6mm, 8mm, 10mm.  
Extra-long arm  
Heat treatment and chrome plate  
Packed by double blister

Unit	PACK /QTY	Qty/Ctn
SET	6	48

8PCS Pocket Torx key

THT1061846

Cr-V

8PCS/SET



T9, T10, T15, T20, T25, T27, T30, T40

8pcs torx key set (Pocket)  
Size: T9, T10, T15, T20, T25, T27, T30, T40.  
Material: Cr-V  
Heat treatment and chrome plate  
Packed by plastic hanger

Unit	PACK /QTY	Qty/Ctn
SET	12	96

100 Pcs Industrial tools set

THKTHP21006

100Pcs

100PCS/SET



100 Pcs Tools Set  
Include:  
1 Pcs 1/2" ratchet wrench, 45T  
18Pcs 1/2" Hexagonal Socket: 10-11-12-13-14-15-16-17-18-19-20-21-22-23-24-27-30-32MM  
2 Pcs 1/2" Extension bar: 125mm (5") / 250mm(10")  
1 Pcs 1/2" Dr. Universal joint  
2 Pcs Spark plug socket  
1/2" Dr. 16MM&21MM  
1 Pcs 1/2" \* 3/8" three way adaptor  
1 Pcs 1/4" ratchet wrench, 45T  
13Pcs 1/4" Hexagonal Socket: 4-4.5-5-5.5-6-7-8-9-10-11-12-13-14

Unit	PACK /QTY	Qty/Ctn
SET	1	2

6 Pcs insulated screwdriver set (VDE Certified)

THTIS566

1000V



6PCS/SET



6 PCS Insulated Screwdriver Set  
SL3.0x75  
SL4.0x100  
SL6.5x150  
PH0x60  
PH1x80  
PH2x100  
New design handle  
1000V/VDE+GS Certification  
Use Aluminum frame with 4pcs Screw and 4pcs Screw Plug  
Round shank  
Packed by double blister

Unit	PACK /QTY	Qty/Ctn
SET	6	24

9PCS Hex key

THT106191

Cr-V

9PCS/SET



9pcs hex key set  
Material: Cr-V  
Size: 1.5mm, 2mm, 2.5mm, 3mm, 4mm, 5mm, 6mm, 8mm, 10mm.  
Long arm  
Heat treatment and chrome plate  
Packed by double blister

Unit	PACK /QTY	Qty/Ctn
SET	6	48

18 Pcs Hex Key And Torx Key Set

THT106KT0181

Cr-V

18PCS/SET



18 Pcs Hex Key And Torx Key Set  
Include:  
9 Pcs Hex Key  
Size:  
1.5mm, 2.0mm, 2.5mm, 3.0mm, 4mm, 5mm, 6mm, 8mm, 10mm.  
9 Pcs Torx Key  
Size: T-10, T-15, T-20, T-25, T-27, T-30, T-40, T-45, T-50  
Extra-long arm  
Material: Cr-V  
Heat treatment and chrome plate  
Packed by double blister

Unit	PACK /QTY	Qty/Ctn
SET	6	24

26PCS insulated hand tools set (VDE Certified)

THKITH2601

1000V



26PCS/SET



26PCS Insulated hand tools set  
1000V, VDE/GS Certification  
Include:  
1Pcs 180mm insulated combination pliers;  
1Pcs 160mm insulated long nose pliers ;  
1Pcs 160mm insulated diagonal cutting pliers ;  
3Pcs insulated slotted screwdrivers: SL3.0x75mm; SL4.0x100mm; SL5.5x125mm;  
2Pcs insulated phillips screwdrivers: PH1x80mm; PH2x100mm;  
14Pcs insulated hexagon sockets 1/2" (10mm, 11mm, 12mm, 13mm,

Unit	PACK /QTY	Qty/Ctn
SET	1	4

17" Plastic Tool Box

TPBX0171

17"

436x220x205mm 17"

Weight: 1390g



17" Plastic Tool Box  
Size : 436mm(17")\*220mm (8.7") \*205mm (8")  
Material: PP  
weight: 1390g  
PP plastic buckle  
Max Load : 15KG  
High-strength Handle  
Upper cover with three storage areas  
Upper cover with scale function  
Contains 1Pcs plastic tray  
Packed by carton box

Unit	PACK /QTY	Qty/Ctn
PCS	1	8

16" Tools bag

THT26161

16"

16"



With **14 Pockets**  
Max Load **15 kgs**

Size: 16"  
Max load: 15kg  
Rigid frame for easy opening and access  
Internal & external pockets for additional storage capacity  
With 6 pockets outside and 8 pockets inside  
Packed by paper card

Unit	PACK /QTY	Qty/Ctn
PCS	10	20

24" Industrial Tool bag(Reinforced Base)

THT16241

24"

24"



With **18 Pockets**  
Max Load **25 kgs**

Size: 24"  
Max load: 25kg  
Rigid frame for easy opening and access  
Reinforced plastic base for durability  
Internal pockets for additional storage capacity  
Adjustable shoulder strap included  
Packed by paper card

Unit	PACK /QTY	Qty/Ctn
PCS	3	6

Tool Vest

TTVT1601

42x60x3cm

42x60x3cm

Max load: 3kg



Size: 42x60x3cm  
Adjustable shoulder straps and waist size  
Air mesh material  
Max load: 3kg  
Multiple use compartments for all storage needs  
With 12 pockets and 1 pcs hammer holder  
Packed by color box

Unit	PACK /QTY	Qty/Ctn
PCS	1	20

3" C clamp

THT13136

3"

75mm(3")



Size: 3"  
Body malleable cast iron  
T-shaped thread  
Packed by paper card

Unit	PACK /QTY	Qty/Ctn
PCS	6	24

2"x10" F clamp

THT1320503

50x250mm

250mm(10")



Clamp size: 50x250mm  
Max clamp force: 170KGS  
Thickness and width of iron ruler: 5X15mm  
Diameter of screw thread: 11mm  
Packed by paper card

Unit	PACK /QTY	Qty/Ctn
PCS	10	50

12" Quick bar clamp

THT1340602

63x300mm

300mm(12")

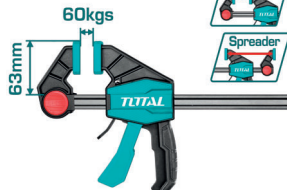

Clamp size: 63x300mm  
Max clamp force: 60KGS  
Thickness and width of iron ruler: 5X18mm  
Packed by label

Unit	PACK /QTY	Qty/Ctn
PCS	1	12

36" Industrial Quick bar clamps

THT1346803

83x900mm

900mm(36")

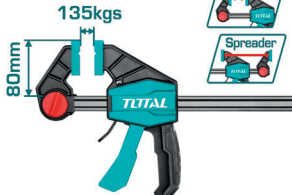

Clamp size: 80x900mm  
Max clamp force: 135KGS  
Thickness and width of iron ruler: 6X18mm  
Packed by label

Unit	PACK /QTY	Qty/Ctn
PCS	1	8

6" Spring clamp

THT13362

6"

150mm(6")



Size: 6"  
Length: 150mm  
Clamping force: 15KGS  
Black clip body  
Max open mouth: 68mm  
Packed by label

Unit	PACK /QTY	Qty/Ctn
PCS	30	120

1" Wood chisel

THT41256

25mm/1"

25mm(1")



Wood Chisel, Cr-V  
Width: 25mm(1")  
Length: 140mm  
Packed by double blister

Unit	PACK /QTY	Qty/Ctn
PCS	10	50

4 Pcs wood chisel set

THT41K0401

Cr-V

4PCS/SET



Wood Chisel  
Wood Chisel, Cr-V  
Width: 6mm, 12mm, 19mm, 25mm  
Length: 140mm  
Packed by Sliding card

Unit	PACK /QTY	Qty/Ctn
SET	4	16

1" Industrial Cold chisel

THT4411219

305mm

**25x19x305mm**  
1"x3/4"x12"

40Cr



Unique design Handle  
Size:25mm\*19mm\*305mm  
Material:40Cr  
Heat treatment,Impid Powder coating  
NEW Style handle  
Packed by plastic hanger

Unit	PACK /QTY	Qty/Ctn
PCS	6	24

12"X3/4" Industrial Concrete chisel

THT4421219

305mm

**4x19x305mm**  
5/32"x3/4"x12"

40Cr



Unique design Handle  
Size:4mm\*19mm\*305mm  
Material:40Cr  
Heat treatment,Impid Powder coating  
NEW Style handle  
Packed by plastic hanger

Unit	PACK /QTY	Qty/Ctn
PCS	6	24

36" Wrecking Bar

THT431362

36"

**900x30x16mm**  
36"x1-1/5"x16/25"



Size (AxBxC) :  
36"(900mm)x1-1/5"(30mm)  
x16/25"(16.0mm)  
Oval shank with notch (30°, 68°)  
Packed by label

Unit	PACK /QTY	Qty/Ctn
PCS	1	6

Hand riveter

THT32104

10.5"



Size: 10.5"  
Applicable rivet  
size:2.4mm, 3.2mm,4mm,4.8mm  
Packed by sliding card

Unit	PACK /QTY	Qty/Ctn
PCS	6	24

Staple gun

THT311425

4-14mm

**4-14mm**



Iron staple gun  
Adjustable driving force  
Wire:0.7mm  
Crown:11.3mm  
Length: 4-14mm  
Packed by double blister

Unit	PACK /QTY	Qty/Ctn
PCS	5	20

6" Mini Hacksaw Frame

THMHF1501

150mm/6"

**150mm(6")**

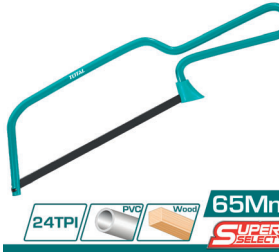

Mini Hacksaw  
Size: 150mm (6")  
With 1 pcs blade  
Packed in paper card

Unit	PACK /QTY	Qty/Ctn
PCS	24	144

12" Industrial Hacksaw frame

THT54106

300mm/12"

**300mm(12")**



Unique design INDUSTRIAL Hacksaw frame  
Size:300mm/12"  
Heavy duty frame  
Aluminum + ABS + TPR handle,Strong and Comfortable  
Adjustable tension  
Quick-release blade changing mechanism  
Including 1pcs 65Mn saw blade  
Packed by paper card

Unit	PACK /QTY	Qty/Ctn
PCS	6	24

6" Industrial Drywall saw SK5

THWBSW66

150mm/6"

**150mm(6")**



Size:6"/150mm  
Material: Taiwan SK5  
BTPI,heat treatment teeth  
Triple teeth(Precision ground teeth 3 edges)  
Fast cut and long life  
Packed by Color sleeve

Unit	PACK /QTY	Qty/Ctn
PCS	6	60

Snap-off blade knife(wheel button)

THT511826

18x100mm

**18x100mm**



Blade Size:18mmx100mm  
With 1 pcs blade ( THT519112)  
Length:173mm  
With round push button  
Packed by sliding card

Unit	PACK /QTY	Qty/Ctn
PCS	12	96

Retractable Utility knife(5 Extra Blades)

THT5116118

61x19mm

**19x61mm**  
Aluminum Alloy



Size:180x45mm  
Blade size:61x19mm  
With 5pcs SK5 blades (THT519001)  
Packed by double blister

Unit	PACK /QTY	Qty/Ctn
PCS	6	72

**10 Pcs 18mm knife blades set**

**THT519112** 18x100mm

**10PCS/BOX** 18X100mm



10Pcs/Set  
Size: 18X100mm  
Suitable for item THT511816/THT511826/  
THT511836/TG5121806/THT51001  
Packed by plastic box

Unit	PACK /QTY	Qty/Ctn
SET	20	120

**25MMX127MM 10PCS blades set**

**THT5192501** 25\*127MM

**10PCS/BOX** 25X127mm  
**SK4**



10Pcs/Set  
SK4  
Size: 25\*127MM  
Packed by plastic box

Unit	PACK /QTY	Qty/Ctn
SET	10	100

**10 Pcs utility knife blades set**

**THT519001** 61x19mm

**10PCS/BOX** 19X61mm



10Pcs/Set  
Size: 61X19mm  
Suitable for item TG5126101/  
THT5116118/THT5126128/THT5136236/  
THT5136288  
Packed by plastic box

Unit	PACK /QTY	Qty/Ctn
SET	20	200

**Heavy duty glass cutter**

**THT561781** 178mm

**178mm**



Automatic  
clipping

Iron body  
Auto oil feed cutter  
With 1pcs oil suction pipe  
Total cutting length:5000m  
length:178mm  
Packed by sliding card

Unit	PACK /QTY	Qty/Ctn
PCS	6	120

**10" Straight Aviation snip**

**THT522106** 250mm/10"

**250mm(10")**



Unique design two tone soft handle  
Aviation snip( Straight)  
Length:250mm (10")  
Max cutting thickness:  
Carbon steel ≤1.2mm  
Stainless steel ≤0.7mm  
Packed by half double blister

Unit	PACK /QTY	Qty/Ctn
PCS	5	40

**3pcs wood file set/8"**

**THT918326** 200mm

**3PCS FILE SET** 200mm(8")



Flat  
Half round  
Round

Size:200mm  
Flat wood file 1pcs  
Half round wood file 1pcs  
Round wood file 1pcs  
Packed by double blister

Unit	PACK /QTY	Qty/Ctn
SET	10	20

**9" Caulking gun (Light Duty)**

**THT20209** 235mm/9"

**230mm(9")**



9" caulking gun  
Thickness: 0.8mm  
Iron shank with teeth  
Length:230mm  
Diameter:55mm  
Packed by label

Suitable for :

Unit	PACK /QTY	Qty/Ctn
PCS	12	24

**9" Skeleton Caulking gun**

**THT21309** 9"

**230mm(9")**



Double  
push plate

9" caulking gun  
Aluminum handle  
Double push plate  
With needle  
Thickness: 2.2mm  
Length:230mm  
Diameter:55mm  
Packed by paper card

Suitable for :

Unit	PACK /QTY	Qty/Ctn
PCS	12	24

**15" (600ML) Sausage Caulking gun**

**THT20115** 375mm/15"

**380mm(15")**



15" aluminum caulking gun  
Strong aluminum handle  
Length:380mm  
Diameter:51mm  
Packed by paper card

Suitable for :

Unit	PACK /QTY	Qty/Ctn
PCS	4	12

**2.5" SS Multifunction Putty trowel**

**THT83606M** 60mm

**63mm(2.5")**



Size:63mm(2.5")  
Thickness:1.8mm  
Fine polished  
NO.1 Clean roller cover  
NO.2 Scrapes  
NO.3 Spreads  
NO.4 Knock  
NO.5 Convex scraper  
Packed by label

Unit	PACK /QTY	Qty/Ctn
PCS	12	120

### 6" Stainless Steel Putty trowel with Aluminum Head

THT6831506

150mm

150mm(6")



Size: 150mm(6")  
With Aluminum head end  
Stainless steel  
Heat treatment  
Fine polished  
Double color plastic handle  
Packed by label

Unit	PACK /QTY	Qty/Ctn
PCS	12	120

### 7" Bricklaying trowel(plastic handle)

THT82746

180mm/7"

180mm(7")



Size: 7"/180mm(plastic handle)  
Diameter of connecting rod:9.5mm  
Unique design handle  
Packed by label

Unit	PACK /QTY	Qty/Ctn
PCS	12	48

### 10" Drywall taping knives

THPUT25011

250mm/10"

250mm(10")



Size: 10"/250mm  
Blade thickness:0.5mm  
Aluminum backing plate  
Unique design handle  
Packed by label

Unit	PACK /QTY	Qty/Ctn
PCS	10	60

### 9.5"X4" Rubber grout float

THT8324106

240x100mm

240x100mm  
Tile Grouting Smooth Finish

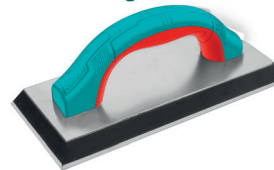

Size:240mmx100mm  
EVA Thickness:19mm  
Pure PP handle  
Aluminium base plate  
Packed by label

Unit	PACK /QTY	Qty/Ctn
PCS	10	40

### Chalk line reel

THT661301

30m

30m

Net weight: 113g/4oz



Chalk line reel  
Length:30m  
With 1 bottle chalk  
With 1 pcs spirit bubble  
With 1 pcs blue powder bottle: 4oz/113g  
Packed by double blister

Unit	PACK /QTY	Qty/Ctn
SET	10	40

### 1.5" Paint brush Plastic Handle

THT846156

1.5"

38mm(1.5")

Bristle Length: 45mm  
Thickness: 11mm



Width: 1.5"  
For Oil-Based paint  
Unique design plastic handle  
Bristle length: 45mm  
Thickness: 11mm  
Packed by label

Unit	PACK /QTY	Qty/Ctn
PCS	12	360

### 2.5" Paint brush(Wooden Handle)

THT84251

63mm/2.5"

63mm(2.5")

Bristle Length: 51mm  
Thickness: 15.5mm



Size: 2.5"(63mm)  
Length: 51mm  
Thickness: 15.5mm  
Wooden handle  
Packed by plastic bag

Unit	PACK /QTY	Qty/Ctn
PCS	12	240

### 2.0" Angle sash brush (Wooden Handle)

THT848026

2.0"

50mm(2")



High quality wooden handle  
100% hollow tapered PET-PBT filaments  
Width: 2.0"  
Copper plating ferrule  
Bristle length: 64mm  
Thickness: 15mm  
Packed by color sleeve

Unit	PACK /QTY	Qty/Ctn
PCS	12	240

### 12" Adjustable wrench

THT1010123

300mm/12"

300mm(12")



Length:300mm(12")  
Adjustable clamp size:0-35mm  
Packed by paper card

Unit	PACK /QTY	Qty/Ctn
PCS	6	24

### 12" Adjustable wrench with rubber handle

THT101126

300mm/12"

300mm(12")



Unique design Handle  
Length:300mm(12"),CrV  
Adjustable clamp size:0-41mm  
Two color rubber handle  
Packed by plastic hanger

Unit	PACK /QTY	Qty/Ctn
PCS	4	16

**32" Industrial Tile cutter**

**THT578004** 800mm

**800mm**



Tile cutter  
Max cutting length:800mm  
Max cutting thickness:14mm  
With 1 pcs bag  
Steel base size:993x165mm  
2pcs steel support frame  
Thickness of the base:2.5mm  
With 1 pcs tungsten carbide ball bearing blade  
Blade size:22x10.5x2mm  
Multi-function:direct line cutting,diagonal line cutting  
With aluminium gauge  
Packed by carton box

Unit	PACK /QTY	Qty/Ctn
PCS	1	2

**3Ton Low Profile Hydraulic floor jack**

**THT10834** 3Ton

**3Ton**



3Ton  
Fast lifting ,dual pump  
Min. height: 85mm  
Max. height: 515mm  
Travel: 430mm  
Net weight: 32kg  
Packed by carton box

Unit	PACK /QTY	Qty/Ctn
PCS	1	1

**3Ton Jack stand**

**THJS0301** 3Ton

**3Ton** 2PCS/Pair



2pcs/pair  
3Ton  
Min. height: 270mm  
Max. height: 410mm  
Net weight: 6.1kg  
Large saddle,more stable  
Packed by color box

Unit	PACK /QTY	Qty/Ctn
PAIR	1	1

**16'x1" Steel measuring tape**

**TMT126352** 5mx25mm

**5mx25mm**



Length & width:5mx25mm  
Double button  
With metric and inch  
Unique design  
Pure ABS material cover  
Packed by label

Unit	PACK /QTY	Qty/Ctn
PCS	12	60

**32'x1" Steel measuring tape(Rubber Cover)**

**TMT126101** 10mx25mm

**10mx25mm**



Length & width:10mx25mm  
With metric and inch  
With 3 stop button function  
With rubber cover  
Packed by plastic hanger

Unit	PACK /QTY	Qty/Ctn
PCS	6	36

**26'x1" Steel measuring tape(NYLON)**

**TMT126681** 8mx25mm

**8mx25mm**



Length & width:8mx25mm  
Nylon blade  
Double side printing  
With metric and inch  
Double hook of blade  
Stronger clip  
Unique design  
Packed by double blister

Unit	PACK /QTY	Qty/Ctn
PCS	5	30

**Digital display measuring wheel**

**TMT19923** 0.1m

**0-99999.9m**



Display resolution:0.1m  
Tolerance: < 0.5%  
Measuring range:0-99999.9m  
With digital display and memory  
With metric and inch dual system  
With stand  
Power supply:2x LRO3 AAA batteries  
Packed by color box

Unit	PACK /QTY	Qty/Ctn
PCS	1	6

**9" Mini Spirit level**

**TMT2267** 225mm



Length: 225mm  
With magnet  
With 3 vials  
Material:ABS plastic  
Packed by Label

Unit	PACK /QTY	Qty/Ctn
PCS	10	100

**32" Heavy Duty Spirit level(With powerful magnets)**

**TMT28056** 80cm

**80cm** HEAVY-DUTY

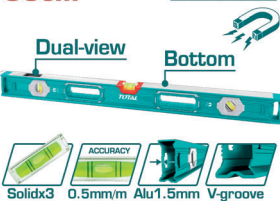

Length: 80cm  
Double side milled  
0.5mm/m accurate vials  
2 Pcs powerful magnets  
Double flat surfaces design  
Packed by color sleeve

Unit	PACK /QTY	Qty/Ctn
PCS	1	10

**40" Heavy Duty Spirit level(With powerful magnets)**

**TMT210056** 100cm

**100cm** HEAVY-DUTY

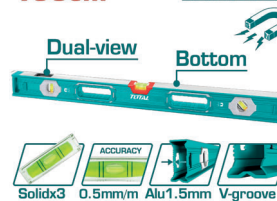

Length: 100cm  
Double side milled  
0.5mm/m accurate vials  
3 Pcs powerful magnets  
Double flat surfaces design  
Packed by color sleeve

Unit	PACK /QTY	Qty/Ctn
PCS	1	10



**7" Angle Square**

**TMT61201** 7in\*7in



**Strong material** **in**

Size: 7in\*7in  
material: ABS  
Only Inch  
Beveled edge for ease of reading  
Easy-to-read gradations  
Base enable easy marking and cutting  
Lightweight & high-impact structural material  
Packed by paper card

Unit	PACK /QTY	Qty/Ctn
PCS	10	60

**12" Angle Square**

**TMT61126** 300mm/12"

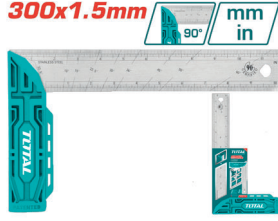

**300x1.5mm** **90°** **mm in**

Length:300mm(12")  
Blade Width:40mm  
Blade Thickness:1.5mm  
Stainless steel blade  
With unique support ledge  
High-impact polymer handle  
Stainless steel blade  
Marking point for pencil  
Packed by paper card

Unit	PACK /QTY	Qty/Ctn
PCS	12	48

**AC Voltage Detector**

**THT2910003** 12~1000V



**12V~1000V AC**

AC Voltage: 12V~1000V(High sensitivity)  
48~1000V(Low sensitivity)  
Frequency:50/60Hz  
Alarm mode: Sound and light alarm  
Flash light : White LED  
Low battery indication  
Auto power off  
Switchable battery cover  
Auto distinguish the Live line and Neutral line  
Packed by double blister

**Live Line** **Neutral Line** **LED** **Flash**

Unit	PACK /QTY	Qty/Ctn
PCS	20	40

**Digital Tread Depth Gauge**

**TMT332501** 0-25.4mm



**25.4mm** **mm in** **3V**

Range:0-25.4mm  
Reading:0.01mm  
Battery 3V  
Metric /inch system conversion at any position  
Battery 3V  
Packed by sliding card

Unit	PACK /QTY	Qty/Ctn
PCS	25	100

**Self-Leveling Line Laser(Green laser beams)**

**TLL305205** 0~30m



**Green laser beams**  
**5 Line**

Green laser beams  
Working Range: 0~30 m  
1 Horizontal Line and 4 Vertical Lines  
Levelling accuracy:±1.0mm at 5 m  
Line accuracy ±1.5mm at 5 m  
Levelling time<3s  
Self-leveling angle ≤3°  
Laser Type : Green  
Laser Class 3R, <5mW  
Without tripods, match with TLLT01152 tripods  
With Cross Lock Function  
With Laser Gain Function  
Operating temperature 0~+40°C  
Storage temperature -20~+70°C

Unit	PACK /QTY	Qty/Ctn
PCS	1	8

**Knitted & PVC dots gloves**

**TSP11102** 10 (XL)



**12 pairs/paper**

Size: 10 (XL)  
Use for transporting and cargo handling worker , recycling worker ,repairer etc.  
Gauge: 10  
Weight:58g /pair; 700g /dozen  
Cotton class: A  
Packed in poly bag

Unit	PACK /QTY	Qty/Ctn
PAIR	12	144

**Nitrile gloves**

**TSP12101** XL



**12 Pairs/Paper**

Size: XL  
Use for oil environment (Less oil)worker etc.  
Nitrile coated palm, smooth and rough-texture palm finish.  
Packed by poly bag

**CE** **EN388 4121X**

Unit	PACK /QTY	Qty/Ctn
PAIR	12	120

**Adjustable Safety goggles**

**TSP301** PC



**4 Different positions**

Material: PC  
The length of temple can be adjusted in 4 different positions, temple line can be added for easier and safer use.  
Integrated encircling type design gives flank protection  
Packed by double blister

**PC**

Unit	PACK /QTY	Qty/Ctn
PCS	12	48

**Safety goggles with Band**

**TSP302** PVC



**Elastic headband**

Has supple and lightweight PVC frame as well unique air hole design.  
High-impact polycarbonate lenses have high transparency comfortable for wearing.  
Packed by poly bag

**PC** **Air hole**

Unit	PACK /QTY	Qty/Ctn
PCS	32	64

**Safety goggles (Only for daily use)**

**TSP306** PC



**Din 9**

Material:PC  
Dark shade:9  
Light weight,comfortable to wear,wide visual field.  
Packed by double blister

**PC**

Unit	PACK /QTY	Qty/Ctn
PCS	12	48

### Earmuff

**TSP701** 24dB

**NRR:24dB**



Impact-resistant ABS shell body, soft foam pad  
NRR:24dB  
Packed by header card

Unit	PACK /QTY	Qty/Ctn
PCS	15	60

### Kneepads

**THKPT0201** 215x180mm

**215x180mm**



Size: 215x180mm  
PVC outer shell provides maximum impact resistance  
Moulded foam body provides extra comfort  
Two elastic straps and flexible buckles ensure a comfortable fit  
Ergonomic design  
Packed by color box

Unit	PACK /QTY	Qty/Ctn
PAIR	1	6

### 32"x1-3/8"X4400LB Ratchet Tie-Down Strap

**THTRS2101** 2Tx10m

**2Tx10m**



Load:2T  
Length:10m  
Width:35mm  
S.F.:2:1  
Ribbon material: PES, secure your equipment  
With ratchet and double J hooks  
Packed by poly bag

Unit	PACK /QTY	Qty/Ctn
SET	1	10

### 8" Pruning Shear

**THT0109** 205mm/8"

**200mm(8")**



Size: 8"/200mm  
Aluminum body pruning shear blade  
Handle non slip treatment  
Max cutting diameter 12mm  
Pack by blister card

Unit	PACK /QTY	Qty/Ctn
PCS	10	60

### 22" Hedge shear

**THT1516301** 557mm

**557mm(22")**



Length:22-7/8"(557mm)  
Material:55# carbon steel  
Heat treatment blade  
Blade painted teflon  
Packed by paper hanger

Unit	PACK /QTY	Qty/Ctn
PCS	6	12

### 28" Lopper

**THT1527101** 725mm/28"

**725mm(28")**



Length:28"(725mm)  
Max cutting diameter:20mm  
Material:55# carbon steel  
Heat treatment blade  
Blade painted teflon  
Packed by paper hanger

Unit	PACK /QTY	Qty/Ctn
PCS	6	12

### 3Pcs Lopper set

**THT1576033** 3Pcs

**3PCS**



3pcs lopper set  
Include:  
1pcs 220MM/8.5" Pruning Shear  
1pcs 580mm/23" Hedge shear  
1pcs 725mm/29" Lopper  
Heat treatment blade  
Blade painted teflon  
Packed by paper card

Unit	PACK /QTY	Qty/Ctn
SET	1	6

### Garden Trowel

**THFTT858** 340mm

**340x85mm**



length:340mm  
Unique design patent handle  
Width:85mm  
Thickness:1.5mm  
Material:carbon steel  
Packed by paper card

Unit	PACK /QTY	Qty/Ctn
PCS	12	48

### Garden Fork

**THFTF38** 320mm

**320x80mm**



length:320mm  
Unique design patent handle  
Width:80mm  
Thickness:2.5mm  
Material:carbon steel  
Packed by paper card

Unit	PACK /QTY	Qty/Ctn
PCS	12	48

### Garden rake

**THFTR1008** 270mm

**90x270mm**



length: 270mm  
Unique design patent handle  
Width:82mm  
Main rod:8.0mm  
Material:carbon steel  
Packed by paper card

Unit	PACK /QTY	Qty/Ctn
PCS	12	48

### Garden rake

**THGT979K**

290mm

**290x75mm**



length:290mm  
Unique design patent handle  
Fork Width:75mm  
Main rod:8.0mm  
Material:carbon steel  
Packed by paper card

Unit	PACK /QTY	Qty/Ctn
PCS	12	48

### 9-Pattern Plastic trigger nozzle

**THWS010901**

3/4"

**9-Way Nozzle**



9-spray patterns  
TPR insulated comfortable soft grip  
Nylon Lever  
Packed by paper hanger

Unit	PACK /QTY	Qty/Ctn
PCS	12	48

### 2pcs watering kit

**THWSK0201**

2pcs

**2PCS/SET**

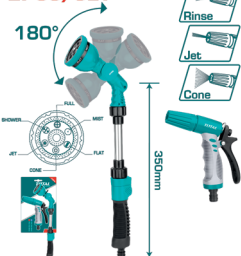

2pcs/set nozzle combo  
1pcs Adjustable 3-Way Plastic Trigger  
Nozzle+3/4" Tool Adaptor  
High-Impact resistant ABS plastic body with TPR  
TPR insulated comfortable soft grip  
1pcs 17" 6-pattern adjustable angle water wand +3/4" tool adaptor  
on/off toggle switch  
Electrolytic bright surface of aluminum tube  
6patterns:full, shower jet cone flat mist  
Nylon lever  
Packed by paper hanger

Unit	PACK /QTY	Qty/Ctn
SET	1	12

### 5-In-1 Plastic Turret sprinkler

**THPS63022**

5-in-1

**5 IN 1**



Plastic 5-in-1 Turret Sprinkler  
3/4" tool adaptor  
Material:ABS  
Net weight:160g  
Packed by paper hanger

Unit	PACK /QTY	Qty/Ctn
PCS	12	48

### Plastic Auto Gear sprinkler

**THPS13601**

3/4"

**227-380m<sup>2</sup>**

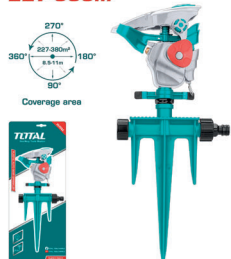

Plastic Auto Gear sprinkler head  
3/4" tool adaptor  
3 Pin plastic spike  
With 360° rotary function  
Dimension: 38\*17.4\*6.4cm  
Material Breakdown: ABS+PP  
Packed by paper hanger

Unit	PACK /QTY	Qty/Ctn
PCS	1	12

### Plastic 3 Arm Rotatory Sprinkler

**THPS23602**

3/4"

**78m<sup>2</sup>**



Plastic Base With Plastic 3 Arm Rotatory Sprinkler  
With 3/4" tool adaptor  
Material Breakdown: ABS and PP  
Dimension: 16.5\*14\*8cm  
Packed by paper hanger

Unit	PACK /QTY	Qty/Ctn
PCS	1	6

### Hand pallet truck

**THT301251**

2500kg

**2500kg**



Capacity Q:2500kg  
Fork size:550\*1150mm  
Distance between forks:230mm  
Min. fork height:85mm  
Max. fork height:200mm  
Steering wheel:φ200\*50mm  
Steering wheel material:polyurethane  
Load roller tandem: φ80\*70mm  
packed by plywood case

Unit	PACK /QTY	Qty/Ctn
PCS	1	6

### 70 MM Heavy duty brass padlock

**TLK32702**

70mm

**70mm**

**HEAVY-DUTY**



Size:70mm  
Material:brass  
Weight:542g  
With 3pcs brass keys  
Packed by double blister

Unit	PACK /QTY	Qty/Ctn
PCS	6	24

### 8" Nylon Cable Ties

**THTCT2001**

200mm

**200x3.6mm**  
100PCS/SET

**PA66**



Color:White  
Material: Nylon 66  
Length:200mm  
Width:3.6mm  
100pcs/set  
two year warranty  
Packed by label

Unit	PACK /QTY	Qty/Ctn
SET	50	200

### 12" Nylon Cable Ties

**THTCT3001**

300mm

**300x4.8mm**  
100PCS/SET

**PA66**



Color:White  
Material: Nylon 66  
Length:300mm  
Width:4.8mm  
100pcs/set  
two year warranty  
Packed by label

Unit	PACK /QTY	Qty/Ctn
SET	50	100

# TOTAL

One-Stop Tools Station

# OMC

**TOOLS & HARDWARE**

**Landline:** (905) 450-0581

**Mobile:** 437 245 9263

**Email:** Info@omctool.com

**Address:** 212B Wilkinson Road, Brampton, Ontario

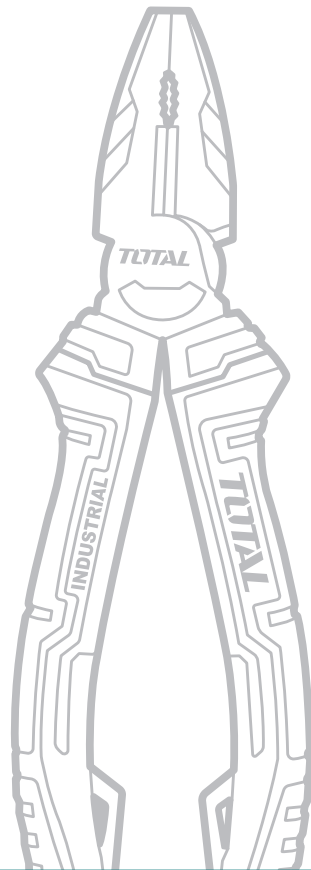

[www.totaltoolscanada.com](http://www.totaltoolscanada.com)  
OMC TOOLS & HARDWARE

TOTAL